

SWING



PL

SWING należy do opraw typu downlight. Charakteryzuje się bardzo dobrą skutecznością świetlną nawet do 118 lm/W. Oprawa przeznaczona jest do montażu w sufitach podwieszanych. SWING posiada regulację położenia, dzięki czemu możliwe jest precyzyjne ukierunkowanie światła. Wychylenie od pionu realizowane jest w zakresie 0-30°, natomiast obrót wokół osi 355°.

EN

SWING is a downlight luminaire. It has very good light efficiency of up to 118 lm/W. This luminaire is intended for installation in suspended ceilings. SWING is adjustable, making it possible to focus the light beam precisely. Vertical deflection is effected in the range of 0-30°, whereas the rotation about the axis of 355°.

DE

SWING ist eine Leuchte Typ Downlight. Sie zeichnet sich durch eine hohe Lichtausbeute, sogar bis 118 lm/W, aus. Die Leuchte ist für die Montage an abgehängten Decken geeignet. SWING verfügt über eine Lageregelung, mit der eine gezielte Lichtrichtung erreicht werden kann. Vertikale Abweichung im Bereich von 0° bis 30°, axiale Drehung 355°.

OPCJE DO WYBORU / OPTIONS / OPTIONSWAHL MÖGLICH:



2700 K 4000 K
3000 K



20° 40°
30° 50°



biały/white/weiß
inny/different/andere*

*Opcje dostępne na zamówienie po konsultacji z działem handlowym. / Options available on request, following consultation with the sales department. / Andere Optionen auf Bestellung nach der Beratung mit der Handelsabteilung erhältlich.

PL

PARAMETRY TECHNICZNE

Sposób montażu: podtynkowy

Obudowa: ABS i aluminium

PARAMETRY ELEKTRYCZNE

Napięcie zasilania: 220-240 V / 50 Hz

Współczynnik mocy (PF): 0,99

Klasa ochronności: I

PARAMETRY UŻYTKOWE

Współczynnik oddawania barw Ra: 85

Stopień ochrony IK: IK07

Stopień ochrony IP: IP40

Temperatura otoczenia: od 0°C do +35°C

Wilgotność otoczenia: 20-80%

Żywotność: 50 000 h

ZASTOSOWANIE: obiekty handlowe, biura, sale konferencyjne, hotele, restauracje, pomieszczenia mieszkalne, obiekty użyteczności publicznej, korytarze

EN

TECHNICAL PARAMETERS

Mounting: flush mounting

Body: ABS and aluminium

ELECTRICAL PARAMETERS

Power Supply: 220-240 V / 50 Hz

Power factor (PF): 0,99

Protection class: I

FUNCTIONAL PARAMETERS

Color rendering index Ra: 85

IK protection marking: IK07

IP protection marking: IP40

Ambient temperature: from 0°C to +35°C

Ambient humidity: 20-80%

Lifetime: 50 000 h

APPLICATION: commercial buildings, offices, conference rooms, hotels, restaurants, residential premises, public utility buildings, corridors

DE

TECHNISCHE DATEN

Montageart: Unterputz-Montage

Gehäuse: ABS und Aluminium

ELEKTRISCHE PARAMETER

Speisespannung: 220-240 V / 50 Hz

Leistungsfaktor (PF): 0,99

Schutzklasse: I

BETRIEBSPARAMETER

Farbwiedergabe Faktor Ra: 85

Schutzklasse IK: IK07

Schutzklasse IP: IP40





Umgebungstemperatur: von 0°C bis +35°C

Umgebungsluftfeuchtigkeit: 20-80%

Lebensdauer: 50 000 h

EINSATZBEREICH: Handelsobjekte, Büros, Konferenzräume, Hotels, Restaurants, Wohnbereiche, öffentliche Gebäude, Korridore

PRODUKTY / PRODUCTS / PRODUKTE:



	CODE	P	T _c				
		[W]	[K]		[°]	[lm]	[lm/W]
SWING	2700K/20W/20	20	2700	-	20	2000	100
SWING	2700K/20W/30	20	2700	-	30	2200	110
SWING	2700K/20W/40	20	2700	-	40	2200	110
SWING	2700K/20W/50	20	2700	-	50	2200	110
SWING	2700K/30W/20	30	2700	-	20	2750	92
SWING	2700K/30W/30	30	2700	-	30	3000	100
SWING	2700K/30W/40	30	2700	-	40	3000	100
SWING	2700K/30W/50	30	2700	-	50	3000	100
SWING	2700K/35W/20	35	2700	-	20	3000	86
SWING	2700K/35W/30	35	2700	-	30	3350	96
SWING	2700K/35W/40	35	2700	-	40	3350	96
SWING	2700K/35W/50	35	2700	-	50	3350	96
SWING	3000K/20W/20	20	3000	-	20	2000	100
SWING	3000K/20W/30	20	3000	-	30	2200	110
SWING	3000K/20W/40	20	3000	-	40	2200	110
SWING	3000K/20W/50	20	3000	-	50	2200	110
SWING	3000K/30W/20	30	3000	-	20	2750	92
SWING	3000K/30W/30	30	3000	-	30	3000	100
SWING	3000K/30W/40	30	3000	-	40	3000	100
SWING	3000K/30W/50	30	3000	-	50	3000	100
SWING	3000K/35W/20	35	3000	-	20	3000	86
SWING	3000K/35W/30	35	3000	-	30	3350	96
SWING	3000K/35W/40	35	3000	-	40	3350	96
SWING	3000K/35W/50	35	3000	-	50	3350	96
SWING	4000K/20W/20	20	4000	-	20	2100	105
SWING	4000K/20W/30	20	4000	-	30	2350	118
SWING	4000K/20W/40	20	4000	-	40	2350	118
SWING	4000K/20W/50	20	4000	-	50	2350	118
SWING	4000K/30W/20	30	4000	-	20	2900	97
SWING	4000K/30W/30	30	4000	-	30	3200	107
SWING	4000K/30W/40	30	4000	-	40	3200	107
SWING	4000K/30W/50	30	4000	-	50	3200	107
SWING	4000K/35W/20	35	4000	-	20	3200	91
SWING	4000K/35W/30	35	4000	-	30	3550	101
SWING	4000K/35W/40	35	4000	-	40	3550	101
SWING	4000K/35W/50	35	4000	-	50	3550	101

Całkowity strumień świetlny oprawy zmierzony za kloszem przy temp. otoczenia 25°C. Tolerancja strumienia świetlnego +/- 10%. Pomiary fotometryczne zostały wykonane zgodnie z wymaganiami normy PN-EN13032. / The total luminous flux of the luminaire measured diffuser 25°C. Luminous flux tolerance +/- 10%. Photometric measurement were examined in accordance with the PN-EN13032 norm. / Gesamtlichtstrom der Leuchte, gemessen hinter der Abdeckung 25°C. Lichtstrom-Toleranz +/- 10%. Photometrische Messungen wurden nach PN-EN13032 Norm geprüft.

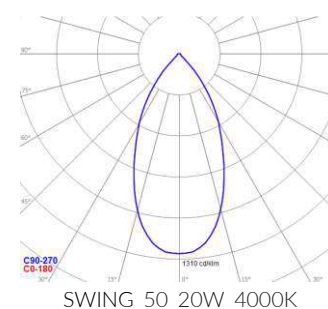
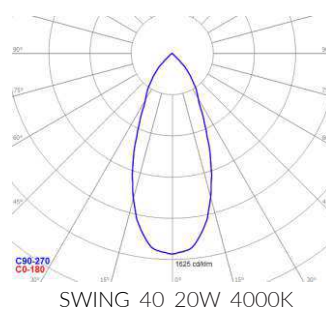
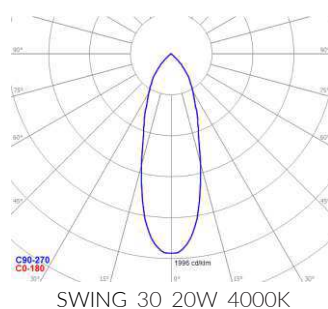
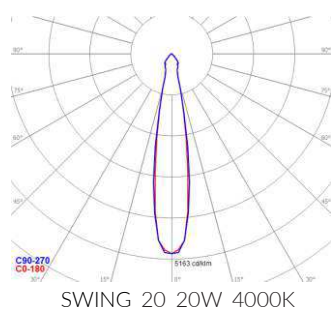
FOTOMETRIA / PHOTOMETRY / PHOTOMETRIE:



WYMIARY / DIMENSIONS / MASSE:

CODE				
	ø [mm]	H [mm]	[kg]	[mm]
SWING	230	142-206	1,5	200

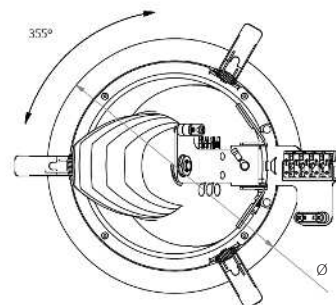
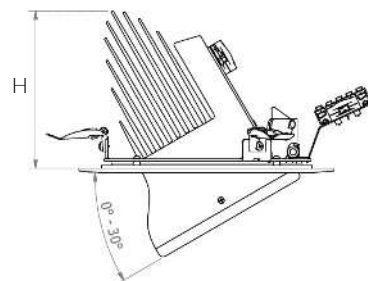

W związku z ciągłym rozwojem produktów zastrzegamy sobie prawo do wprowadzania zmian konstrukcyjnych w oprawach oraz aktualizowania parametrów.
 Due to continuous product development, we reserve the right to introduce structural changes in the fixtures and to update their parameters.
 Aufgrund der ständigen Produktentwicklung behalten wir uns das Recht vor, technische Änderungen und Aktualisierung von Parametern an Leuchten vorzunehmen.

Data aktualizacji / Revision Date / Datum der letzten Aktualisierung: 04.03.2016

LEGENDA / LEGENDA / LEGENDA:

	Deklaracja zgodności Declaration of conformity EG-Konformitätserklärung		Klasa ochronności I Protection class I Schutzklasse I		Napięcie zasilania Power supply Speisespannung
	Źródło światła LED LED source LED Quelle		Klasa efektywności energetycznej Energy efficiency class Energieeffizienzklasse		Dyrektywa RoHS The RoHS Directive RoHS Richtlinie
	Współczynnik mocy Power factor Leistungsfaktor		Stopień ochrony IP IP protection marking Schutzklasse IP		Atest higieniczny PZH Hygiene certificate of the NIH Attest von Polnischer Hygieneanstalt
	Kod produktu Code Artikelnummer		Rodzaj klosza Cover Abdeckung		Moc oprawy Luminaire power Leistung der Leuchte
	Kąt rozsyłu światłości Light distribution angle Winkel der Lichtverteilung		Wymiary Dimensions Masse		Temperatura barwowa Color temperature Farbtemperatur
	Strumień świetlny Luminous flux Lichtstrom		Skuteczność świetlna Luminous efficiency Lichtausbeute der Leuchte		System sterowania DALI DALI control system Steuersystem DALI
	Kolor oprawy Luminaire color Leuchte Farbe		Waga Weight Gewicht		